

# High-Linearity, 815MHz to 1000MHz Upconversion/ Downconversion Mixer with LO Buffer/Switch

## General Description

The MAX2031 high-linearity passive upconverter or downconverter mixer is designed to provide +36dBm IIP3, 7dB NF, and 7dB conversion loss for an 815MHz to 1000MHz RF frequency range to support GSM/cellular base-station transmitter or receiver applications. With a 960MHz to 1180MHz LO frequency range, this particular mixer is ideal for high-side LO injection architectures. For a pin-to-pin-compatible mixer meant for low-side LO injection, contact the factory.

In addition to offering excellent linearity and noise performance, the MAX2031 also yields a high level of component integration. This device includes a double-balanced passive mixer core, a dual-input LO selectable switch, and an LO buffer. On-chip baluns are also integrated to allow for a single-ended RF input for downconversion (or RF output for upconversion), and single-ended LO inputs. The MAX2031 requires a nominal LO drive of 0dBm, and supply current is guaranteed to be below 100mA.

The MAX2031 is pin compatible with the MAX2039/MAX2041\* 1700MHz to 2200MHz mixers, making this family of passive upconverters and downconverters ideal for applications where a common PC board layout is used for both frequency bands.

The MAX2031 is available in a compact 20-pin thin QFN package (5mm x 5mm) with an exposed paddle. Electrical performance is guaranteed over the extended -40°C to +85°C temperature range.

## Applications

Cellular Band WCDMA and cdma2000<sup>®</sup> Base Stations

GSM 850/GSM 900 2G and 2.5G EDGE Base Stations

Integrated Digital Enhanced Network (iDEN<sup>®</sup>) Base Stations

WiMAX<sup>(SM)</sup> Base Stations and Customer Premise Equipment

Predistortion Receivers

Microwave and Fixed Broadband Wireless Access

Wireless Local Loop

Digital and Spread-Spectrum

Communication Systems

\*Future product—contact factory for availability.

cdma2000 is a registered trademark of Telecommunications Industry Association.

iDEN is a registered trademark of Motorola, Inc.

WiMAX is a service mark of Bandwidth.com, Inc.

## Features

- ◆ 815MHz to 1000MHz RF Frequency Range
- ◆ 960MHz to 1180MHz LO Frequency Range
- ◆ 325MHz to 850MHz LO Frequency Range (Contact Factory)
- ◆ DC to 250MHz IF Frequency Range
- ◆ 7dB Conversion Loss
- ◆ +36dBm Input IP3
- ◆ +27dBm Input 1dB Compression Point
- ◆ 7dB Noise Figure
- ◆ Integrated LO Buffer
- ◆ Integrated RF and LO Baluns
- ◆ Low -3dBm to +3dBm LO Drive
- ◆ Built-In SPDT LO Switch with 49dB LO1 to LO2 Isolation and 50ns Switching Time
- ◆ Pin Compatible with the MAX2039/MAX2041 1700MHz to 2200MHz Mixers
- ◆ External Current-Setting Resistor Provides Option for Operating Mixer in Reduced-Power/Reduced-Performance Mode
- ◆ Lead-Free Package Available

## Ordering Information

PART	TEMP RANGE	PIN-PACKAGE	PKG CODE
MAX2031ETP/-T	-40°C to +85°C	20 Thin QFN-EP** (5mm x 5mm)	T2055-3
MAX2031ETP/+T	-40°C to +85°C	20 Thin QFN-EP** (5mm x 5mm)	T2055-3

\*\*EP = Exposed paddle.

+ Denotes lead-free package.

## Pin Configuration/ Functional Diagram

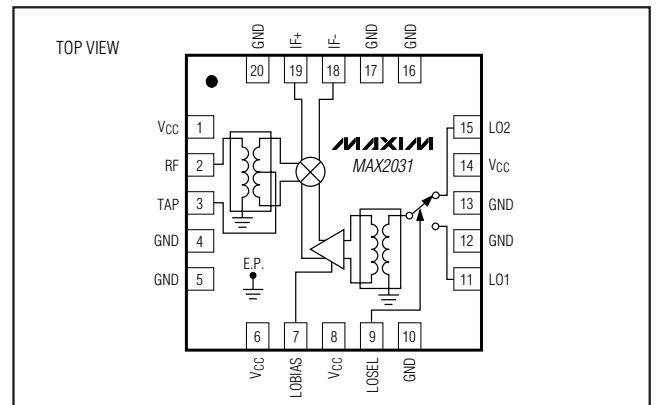

# High-Linearity, 815MHz to 1000MHz Upconversion/Downconversion Mixer with LO Buffer/Switch

## ABSOLUTE MAXIMUM RATINGS

V <sub>CC</sub> to GND.....	-0.3V to +5.5V	Continuous Power Dissipation (T <sub>A</sub> = +70°C)
RF (RF is DC shorted to GND through a balun).....	50mA	20-Pin Thin QFN-EP (derate 26.3mW/°C above +70°C) ....
LO1, LO2 to GND.....	-0.3V to +0.3V	2.1W
IF+, IF- to GND.....	-0.3V to (V <sub>CC</sub> + 0.3V)	θ <sub>JA</sub> .....
TAP to GND.....	-0.3V to +1.4V	θ <sub>JC</sub> .....
LOSEL to GND.....	-0.3V to (V <sub>CC</sub> + 0.3V)	Operating Temperature Range (Note A).....
LOBIAS to GND.....	-0.3V to (V <sub>CC</sub> + 0.3V)	T <sub>C</sub> = -40°C to +85°C
RF, LO1, LO2 Input Power* .....	+20dBm	Junction Temperature.....
		+150°C
		Storage Temperature Range .....
		-65°C to +150°C
		Lead Temperature (soldering, 10s) .....
		+300°C

**Note A:** T<sub>C</sub> is the temperature on the exposed paddle of the package.

\*Maximum reliable continuous input power applied to the RF and IF port of this device is +12dBm from a 50Ω source.

Stresses beyond those listed under "Absolute Maximum Ratings" may cause permanent damage to the device. These are stress ratings only, and functional operation of the device at these or any other conditions beyond those indicated in the operational sections of the specifications is not implied. Exposure to absolute maximum rating conditions for extended periods may affect device reliability.

## DC ELECTRICAL CHARACTERISTICS

(Typical Application Circuit, V<sub>CC</sub> = +4.75V to +5.25V, no RF signals applied, T<sub>C</sub> = -40°C to +85°C. IF+ and IF- are DC grounded through an IF balun. Typical values are at V<sub>CC</sub> = +5V, T<sub>C</sub> = +25°C, unless otherwise noted.)

PARAMETER	SYMBOL	CONDITIONS	MIN	TYP	MAX	UNITS
Supply Voltage	V <sub>CC</sub>		4.75	5.00	5.25	V
Supply Current	I <sub>CC</sub>			85	100	mA
LOSEL Input-Logic Low	V <sub>IL</sub>				0.8	V
LOSEL Input-Logic High	V <sub>IH</sub>		2			V

## AC ELECTRICAL CHARACTERISTICS

(Typical Application Circuit, C5 = 2pF, L1 and C4 not used, V<sub>CC</sub> = +4.75V to +5.25V, RF and LO ports are driven from 50Ω sources, P<sub>LO</sub> = -3dBm to +3dBm, P<sub>RF</sub> = 0dBm, f<sub>RF</sub> = 815MHz to 1000MHz, f<sub>LO</sub> = 960MHz to 1180MHz, f<sub>IF</sub> = 160MHz, f<sub>LO</sub> > f<sub>RF</sub>, T<sub>C</sub> = -40°C to +85°C, unless otherwise noted. Typical values are at V<sub>CC</sub> = +5V, P<sub>LO</sub> = 0dBm, f<sub>RF</sub> = 910MHz, f<sub>LO</sub> = 1070MHz, f<sub>IF</sub> = 160MHz, T<sub>C</sub> = +25°C, unless otherwise noted.) (Note 1)

PARAMETER	SYMBOL	CONDITIONS	MIN	TYP	MAX	UNITS
RF Frequency Range	f <sub>RF</sub>	(Note 2)	815		1000	MHz
LO Frequency Range	f <sub>LO</sub>	(Note 2)	960		1180	MHz
		Contact factory	325		850	
IF Frequency Range	f <sub>IF</sub>	External IF transformer dependence (Note 2)	DC		250	MHz
LO Drive	P <sub>LO</sub>	(Note 2)	-3		+3	dBm
LO1-to-LO2 Isolation (Note 3)		LO2 selected, P <sub>LO</sub> = +3dBm, T <sub>C</sub> = +25°C	42	51		dB
		LO1 selected, P <sub>LO</sub> = +3dBm, T <sub>C</sub> = +25°C	42	49		
Maximum LO Leakage at RF Port		P <sub>LO</sub> = +3dBm		-27		dBm
Maximum LO Leakage at IF Port		P <sub>LO</sub> = +3dBm		-35		dBm
LO Switching Time		50% of LOSEL to IF, settled within 2 degrees		50		ns
Minimum RF-to-IF Isolation				45		dB
RF Port Return Loss				17		dB
LO Port Return Loss		LO1/LO2 port selected, LO2/LO1, RF, and IF terminated into 50Ω		28		dB
		LO1/LO2 port unselected, LO2/LO1, RF, and IF terminated into 50Ω		30		
IF Port Return Loss		LO driven at 0dBm, RF terminated into 50Ω		17		dB

# High-Linearity, 815MHz to 1000MHz Upconversion/ Downconversion Mixer with LO Buffer/Switch

## AC ELECTRICAL CHARACTERISTICS (DOWNCONVERTER OPERATION)

(Typical Application Circuit, C5 = 2pF, L1 and C4 not used, V<sub>CC</sub> = +4.75V to +5.25V, RF and LO ports are driven from 50Ω sources, P<sub>LO</sub> = -3dBm to +3dBm, P<sub>RF</sub> = 0dBm, f<sub>RF</sub> = 815MHz to 1000MHz, f<sub>LO</sub> = 960MHz to 1180MHz, f<sub>IF</sub> = 160MHz, f<sub>LO</sub> > f<sub>RF</sub>, T<sub>C</sub> = -40°C to +85°C, unless otherwise noted. Typical values are at V<sub>CC</sub> = +5V, P<sub>LO</sub> = 0dBm, f<sub>RF</sub> = 910MHz, f<sub>LO</sub> = 1070MHz, f<sub>IF</sub> = 160MHz, T<sub>C</sub> = +25°C, unless otherwise noted.) (Note 1)

PARAMETER	SYMBOL	CONDITIONS	MIN	TYP	MAX	UNITS
Conversion Loss	Lc			7.0		dB
Conversion Loss Flatness		Flatness over any one of three frequency bands (f <sub>IF</sub> = 160MHz): f <sub>RF</sub> = 827MHz to 849MHz f <sub>RF</sub> = 869MHz to 894MHz f <sub>RF</sub> = 880MHz to 915MHz		±0.18		dB
Conversion Loss Variation Over Temperature		T <sub>C</sub> = +25°C to -40°C		-0.3		dB
		T <sub>C</sub> = +25°C to +85°C		0.2		
Input Compression Point	P <sub>1dB</sub>	(Note 4)		27		dBm
Input Third-Order Intercept Point	IIP3	f <sub>RF1</sub> = 910MHz, f <sub>RF2</sub> = 911MHz, P <sub>RF</sub> = 0dBm/tone, f <sub>LO</sub> = 1070MHz, P <sub>LO</sub> = 0dBm, T <sub>C</sub> = +25°C (Note 3)	32	36		dBm
Input IP3 Variation Over Temperature	IIP3	T <sub>C</sub> = +25°C to -40°C		0.3		dB
		T <sub>C</sub> = +25°C to +85°C		-0.3		
Spurious Response at IF	2 x 2	2LO - 2RF		72		dBc
	3 x 3	3LO - 3RF		79		
Noise Figure	NF	Single sideband		7.0		dB
Noise Figure Under Blocking (Note 5)		P <sub>BLOCKER</sub> = +8dBm		15		dB
		P <sub>BLOCKER</sub> = +12dBm		19		

## AC ELECTRICAL CHARACTERISTICS (UPCONVERTER OPERATION)

(Typical Application Circuit, L1 = 4.7nH, C4 = 6pF, C5 not used, V<sub>CC</sub> = +4.75V to +5.25V, RF and LO ports are driven from 50Ω sources, P<sub>LO</sub> = -3dBm to +3dBm, P<sub>IF</sub> = 0dBm, f<sub>RF</sub> = 815MHz to 1000MHz, f<sub>LO</sub> = 960MHz to 1180MHz, f<sub>IF</sub> = 160MHz, f<sub>LO</sub> > f<sub>RF</sub>, T<sub>C</sub> = -40°C to +85°C, unless otherwise noted. Typical values are at V<sub>CC</sub> = +5V, P<sub>LO</sub> = 0dBm, f<sub>RF</sub> = 910MHz, f<sub>LO</sub> = 1070MHz, f<sub>IF</sub> = 160MHz, T<sub>C</sub> = +25°C, unless otherwise noted.) (Note 1)

PARAMETER	SYMBOL	CONDITIONS	MIN	TYP	MAX	UNITS
Conversion Loss	Lc			7.4		dB
Conversion Loss Flatness		Flatness over any one of three frequency bands (f <sub>IF</sub> = 160MHz): f <sub>RF</sub> = 827MHz to 849MHz f <sub>RF</sub> = 869MHz to 894MHz f <sub>RF</sub> = 880MHz to 915MHz		±0.3		dB
Conversion Loss Variation Over Temperature		T <sub>C</sub> = +25°C to -40°C		-0.3		dB
		T <sub>C</sub> = +25°C to +85°C		0.4		
Input Compression Point	P <sub>1dB</sub>	(Note 4)		27		dBm
Input Third-Order Intercept Point	IIP3	f <sub>IF1</sub> = 160MHz, f <sub>IF2</sub> = 161MHz, P <sub>IF</sub> = 0dBm/tone, f <sub>LO</sub> = 1070MHz, P <sub>LO</sub> = 0dBm, T <sub>C</sub> = +25°C (Note 3)	32	36		dBm
Input IP3 Variation Over Temperature	IIP3	T <sub>C</sub> = +25°C to -40°C		1.2		dB
		T <sub>C</sub> = +25°C to +85°C		-0.9		

# High-Linearity, 815MHz to 1000MHz Upconversion/ Downconversion Mixer with LO Buffer/Switch

## AC ELECTRICAL CHARACTERISTICS (UPCONVERTER OPERATION) (continued)

(Typical Application Circuit, L1 = 4.7nH, C4 = 6pF, C5 not used, V<sub>CC</sub> = +4.75V to +5.25V, RF and LO ports are driven from 50Ω sources, P<sub>LO</sub> = -3dBm to +3dBm, P<sub>IF</sub> = 0dBm, f<sub>RF</sub> = 815MHz to 1000MHz, f<sub>LO</sub> = 960MHz to 1180MHz, f<sub>IF</sub> = 160MHz, f<sub>LO</sub> > f<sub>RF</sub>, T<sub>C</sub> = -40°C to +85°C, unless otherwise noted. Typical values are at V<sub>CC</sub> = +5V, P<sub>LO</sub> = 0dBm, f<sub>RF</sub> = 910MHz, f<sub>LO</sub> = 1070MHz, f<sub>IF</sub> = 160MHz, T<sub>C</sub> = +25°C, unless otherwise noted.) (Note 1)

PARAMETER	SYMBOL	CONDITIONS	MIN	TYP	MAX	UNITS
LO ± 2IF Spur				64		dBc
LO ± 3IF Spur				83		dBc
Output Noise Floor		P <sub>OUT</sub> = 0dBm (Note 5)		-167		dBm/Hz

**Note 1:** All limits include external component losses. Output measurements are taken at IF or RF port of the *Typical Application Circuit*.

**Note 2:** Operation outside this range is possible, but with degraded performance of some parameters.

**Note 3:** Guaranteed by design.

**Note 4:** Compression point characterized. It is advisable not to continuously operate the mixer RF/IF inputs above +12dBm.

**Note 5:** Measured with external LO source noise filtered, so its noise floor is -174dBm/Hz. This specification reflects the effects of all SNR degradations in the mixer, including the LO noise as defined in *Maxim Application Note 2021*.

# High-Linearity, 815MHz to 1000MHz Upconversion/Downconversion Mixer with LO Buffer/Switch

## Typical Operating Characteristics

(Typical Application Circuit, C5 = 2pF, L1 and C4 not used, V<sub>CC</sub> = +5.0V, P<sub>LO</sub> = 0dBm, P<sub>RF</sub> = 0dBm, f<sub>LO</sub> > f<sub>RF</sub>, f<sub>IF</sub> = 160MHz, unless otherwise noted.)

### Downconverter Curves

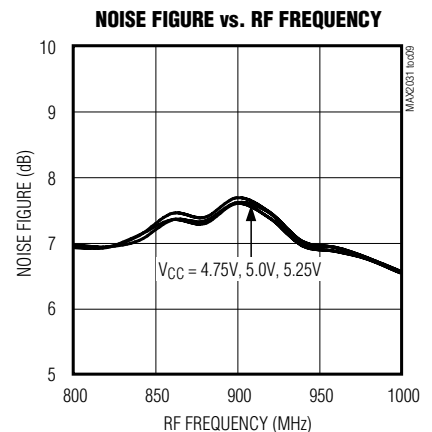
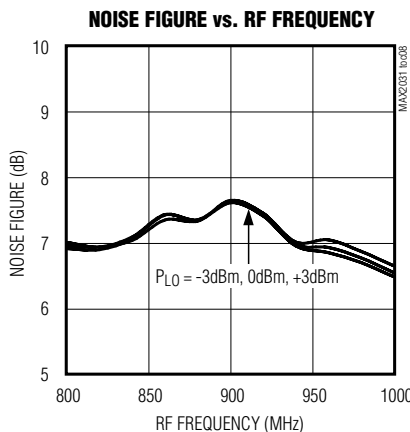
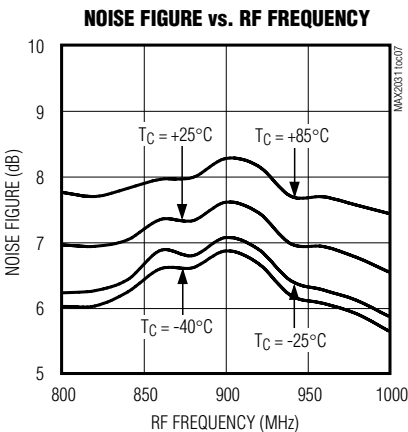
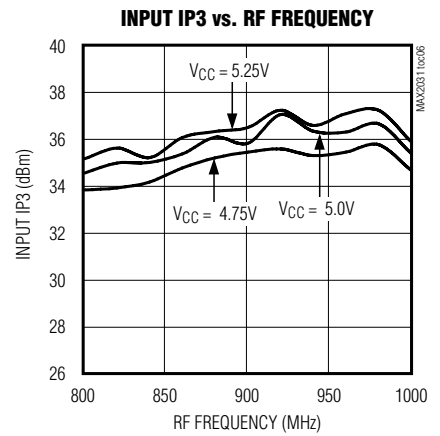
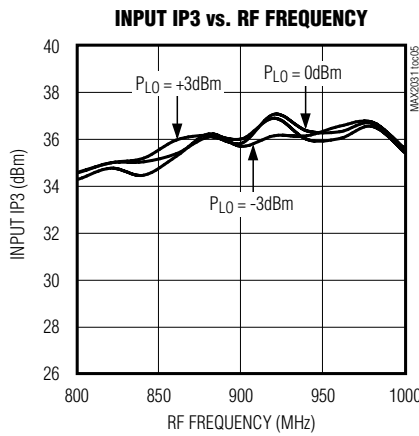
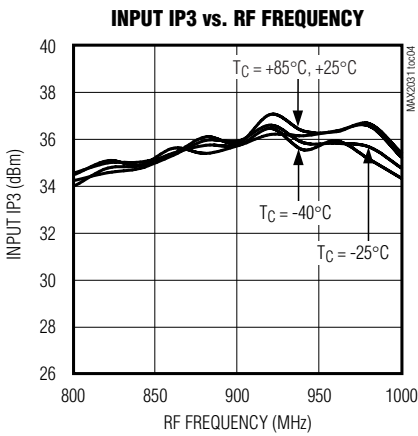
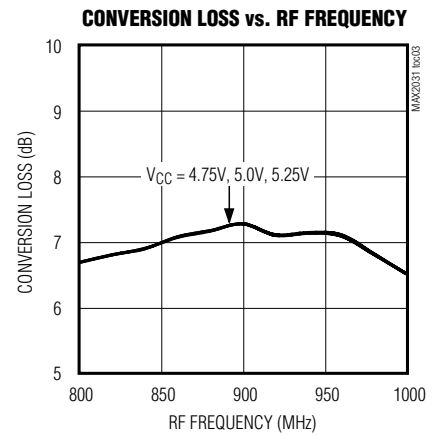
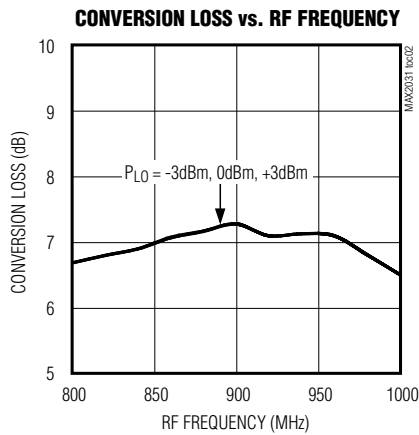
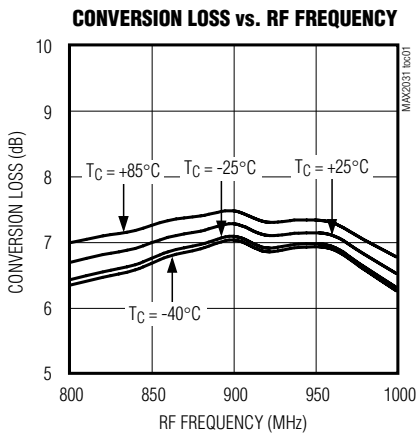

# High-Linearity, 815MHz to 1000MHz Upconversion/Downconversion Mixer with LO Buffer/Switch

## Typical Operating Characteristics (continued)

(Typical Application Circuit, C5 = 2pF, L1 and C4 not used, V<sub>CC</sub> = +5.0V, P<sub>LO</sub> = 0dBm, P<sub>RF</sub> = 0dBm, f<sub>LO</sub> > f<sub>RF</sub>, f<sub>IF</sub> = 160MHz, unless otherwise noted.)

### Downconverter Curves

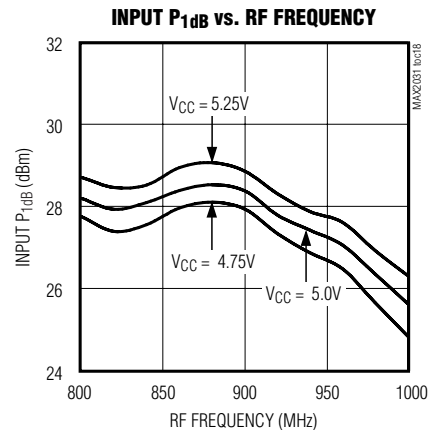
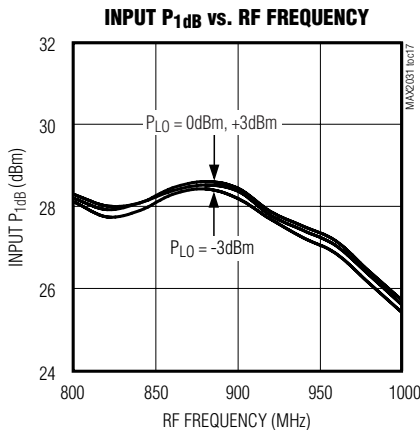
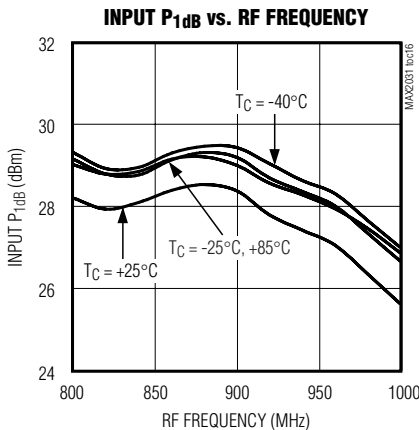
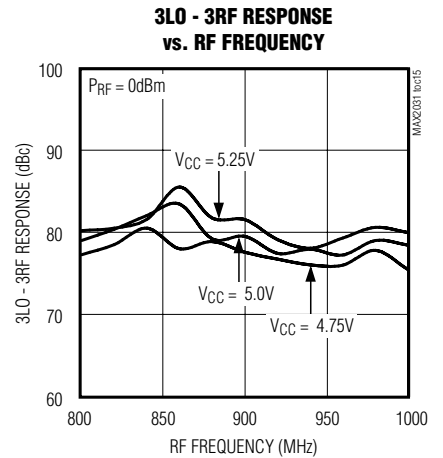
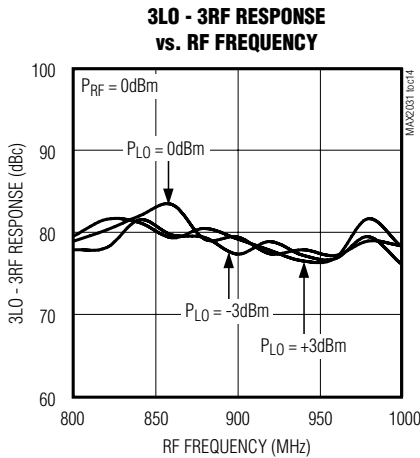
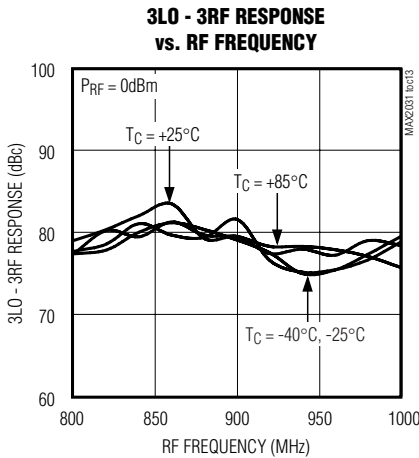
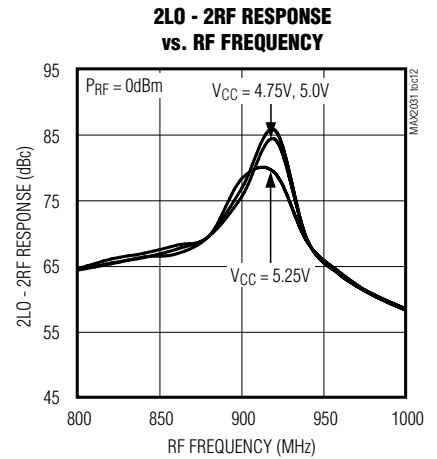
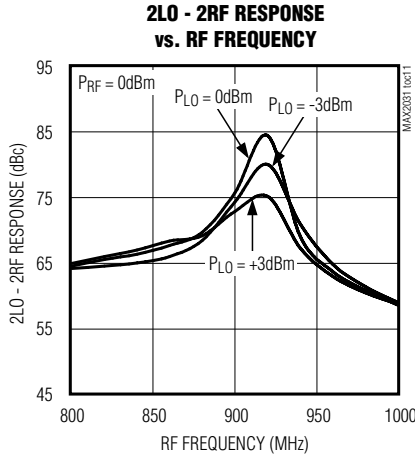
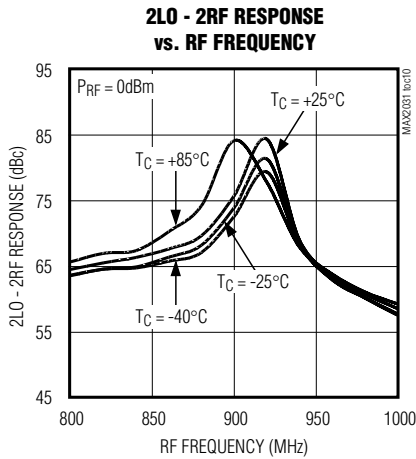

# High-Linearity, 815MHz to 1000MHz Upconversion/Downconversion Mixer with LO Buffer/Switch

## Typical Operating Characteristics (continued)

(Typical Application Circuit, C5 = 2pF, L1 and C4 not used, V<sub>CC</sub> = +5.0V, P<sub>LO</sub> = 0dBm, P<sub>RF</sub> = 0dBm, f<sub>LO</sub> > f<sub>RF</sub>, f<sub>IF</sub> = 160MHz, unless otherwise noted.)

### Downconverter Curves

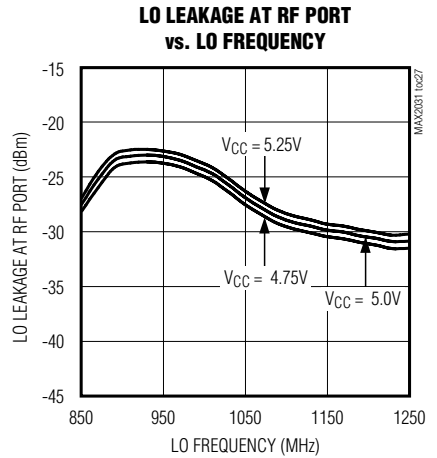
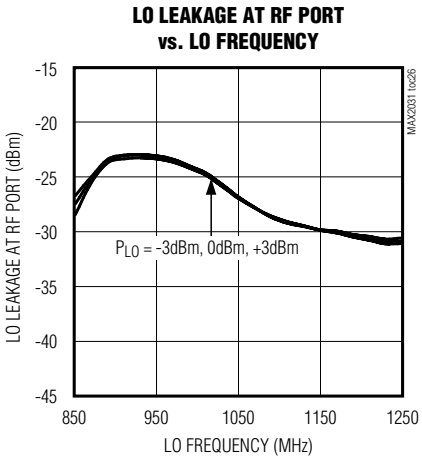
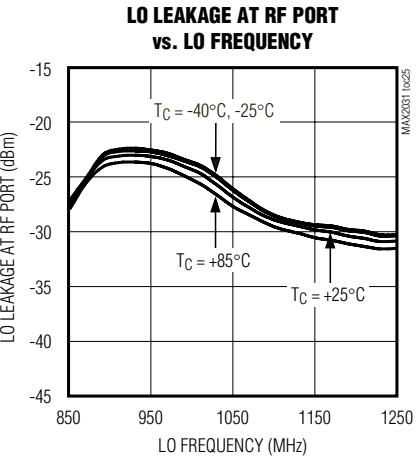
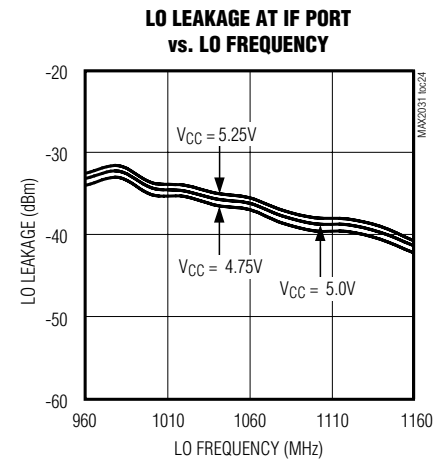
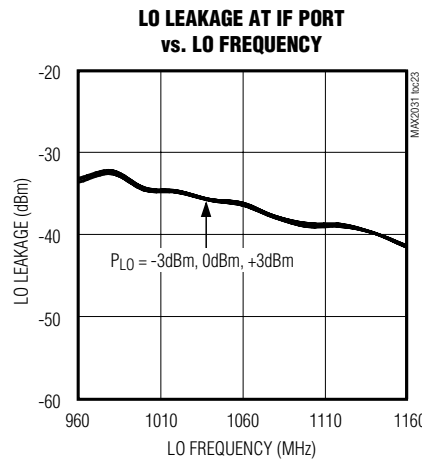
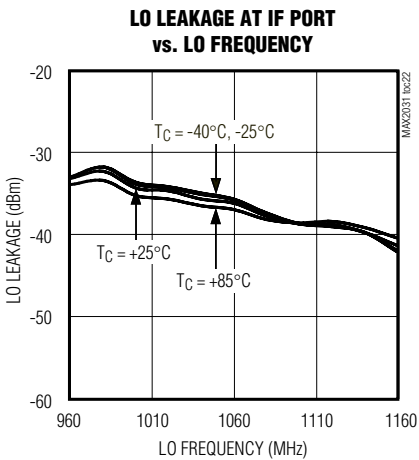
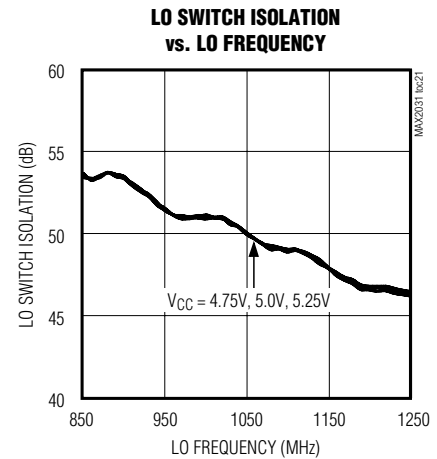
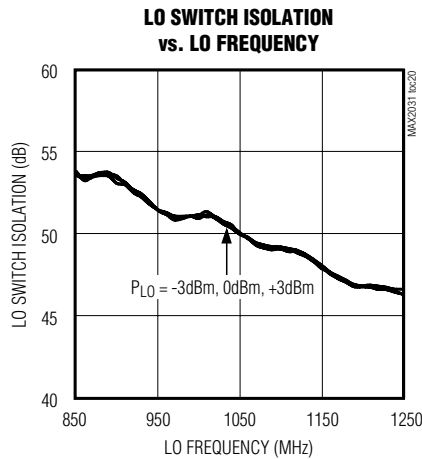
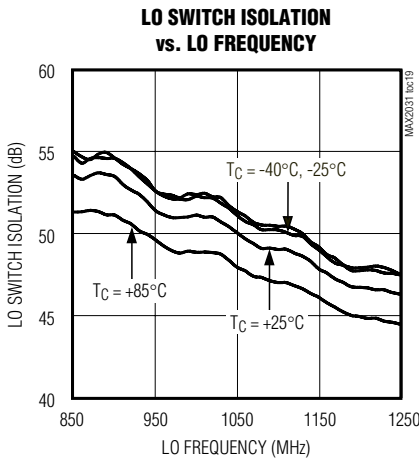

# High-Linearity, 815MHz to 1000MHz Upconversion/Downconversion Mixer with LO Buffer/Switch

## Typical Operating Characteristics (continued)

(Typical Application Circuit, C5 = 2pF, L1 and C4 not used, VCC = +5.0V, PLO = 0dBm, PRF = 0dBm, fLO > fRF, fIF = 160MHz, unless otherwise noted.)

### Downconverter Curves

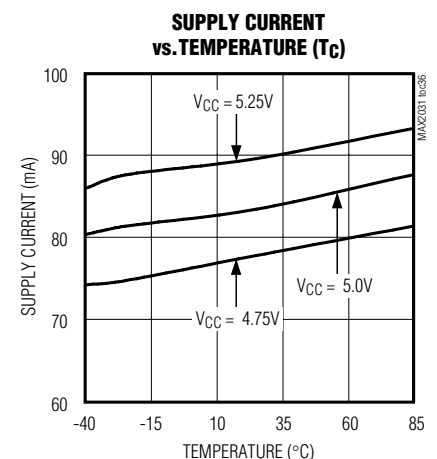
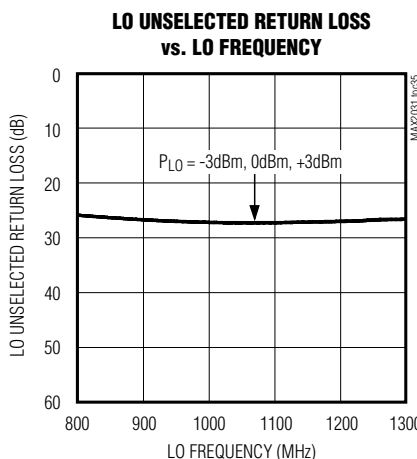
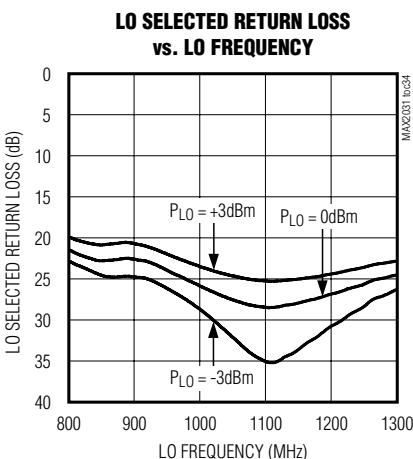
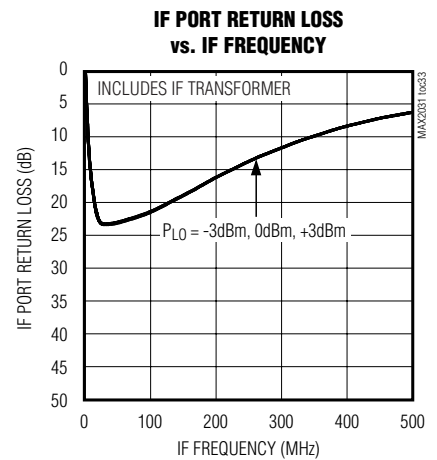
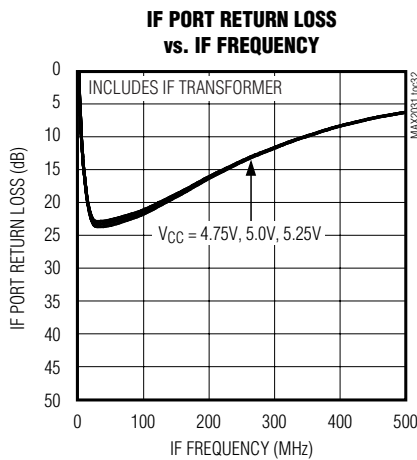
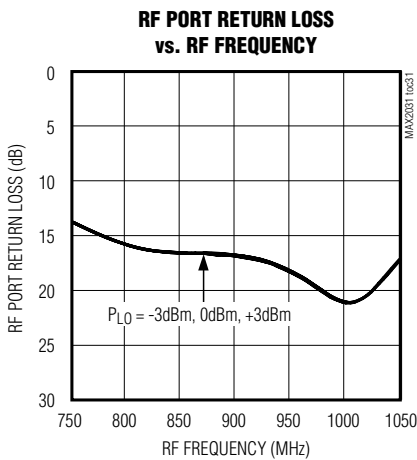
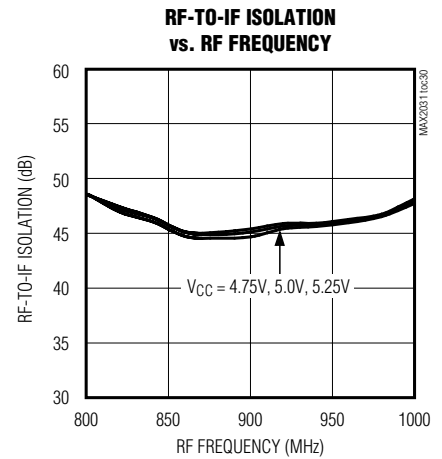
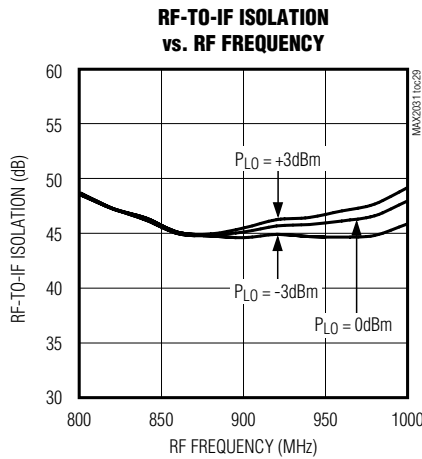
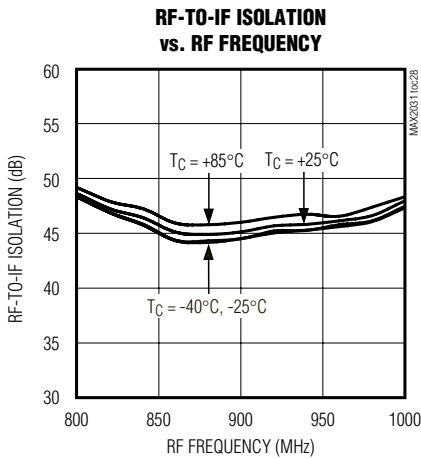



# High-Linearity, 815MHz to 1000MHz Upconversion/Downconversion Mixer with LO Buffer/Switch

## Typical Operating Characteristics

(Typical Application Circuit, L1 = 4.7nH, C4 = 6pF, C5 not used, VCC = +5.0V, PLO = 0dBm, PIF = 0dBm, fRF = fLO + fIF, fIF = 160MHz, unless otherwise noted.)

### Upconverter Curves

**CONVERSION LOSS vs. RF FREQUENCY**  
(L-C BPF TUNED FOR 810MHz RF FREQUENCY)

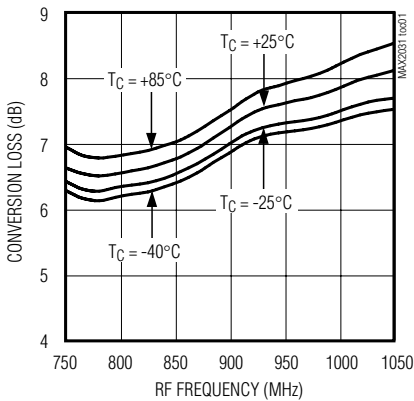

**CONVERSION LOSS vs. RF FREQUENCY**  
(L-C BPF TUNED FOR 810MHz RF FREQUENCY)

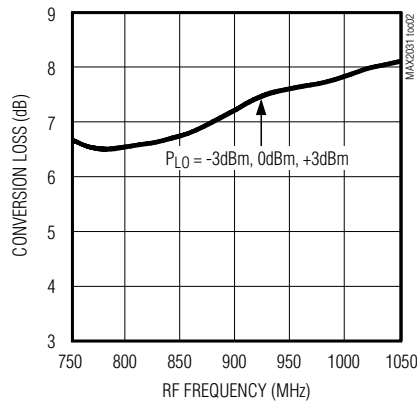

**CONVERSION LOSS vs. RF FREQUENCY**  
(L-C BPF TUNED FOR 810MHz RF FREQUENCY)

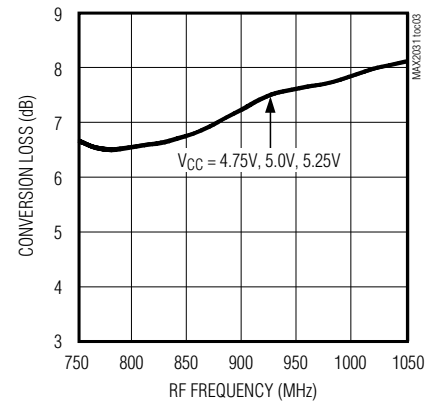

**INPUT IP3 vs. RF FREQUENCY**  
(L-C BPF TUNED FOR 810MHz RF FREQUENCY)

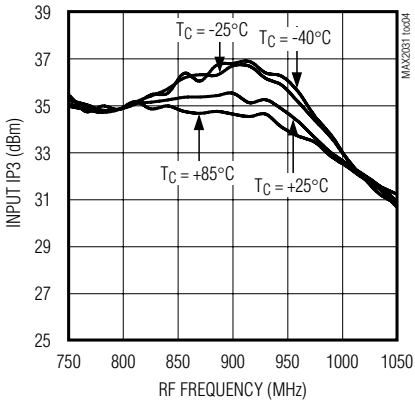

**INPUT IP3 vs. RF FREQUENCY**  
(L-C BPF TUNED FOR 810MHz RF FREQUENCY)

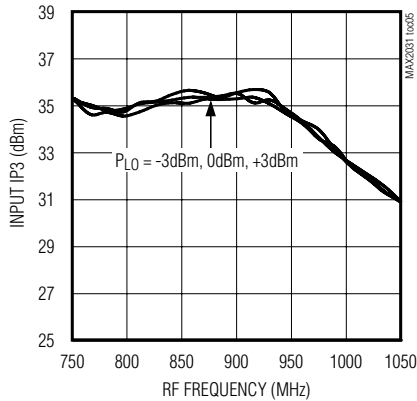

**INPUT IP3 vs. RF FREQUENCY**  
(L-C BPF TUNED FOR 810MHz RF FREQUENCY)

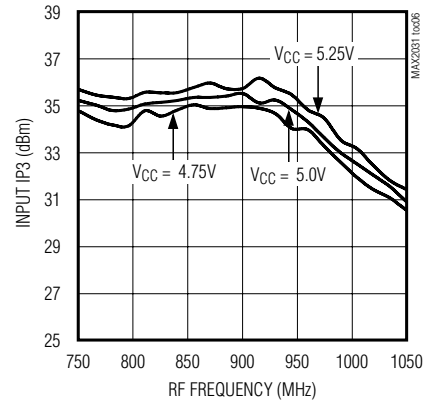

**LO + 2IF REJECTION vs. LO FREQUENCY**  
(L-C BPF TUNED FOR 810MHz RF FREQUENCY)

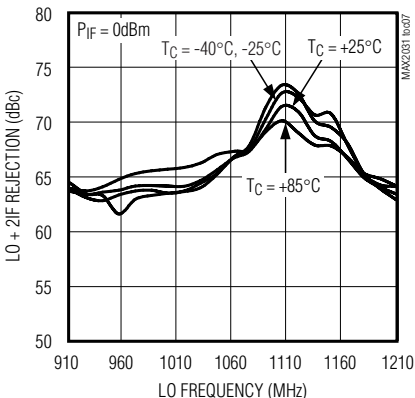

**LO + 2IF REJECTION vs. LO FREQUENCY**  
(L-C BPF TUNED FOR 810MHz RF FREQUENCY)

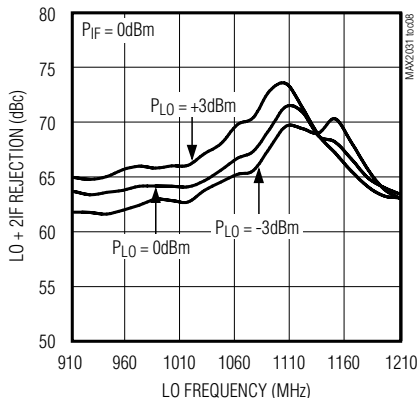

**LO + 2IF REJECTION vs. LO FREQUENCY**  
(L-C BPF TUNED FOR 810MHz RF FREQUENCY)

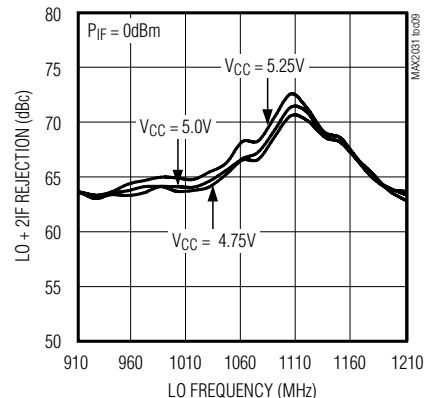

# High-Linearity, 815MHz to 1000MHz Upconversion/Downconversion Mixer with LO Buffer/Switch

## Typical Operating Characteristics (continued)

(Typical Application Circuit, L1 = 4.7nH, C4 = 6pF, C5 not used, VCC = +5.0V, PLO = 0dBm, PIF = 0dBm, fRF = fLO + fIF, fIF = 160MHz, unless otherwise noted.)

### Upconverter Curves

**LO - 2IF REJECTION vs. LO FREQUENCY  
(L-C BPF TUNED FOR 810MHz RF FREQUENCY)**

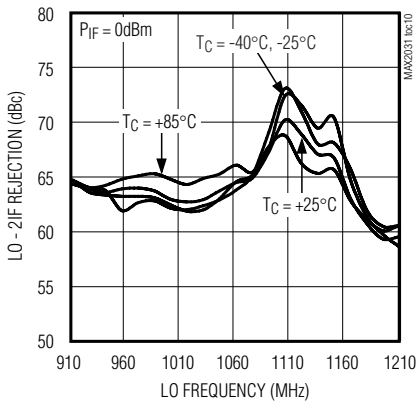

**LO - 2IF REJECTION vs. LO FREQUENCY  
(L-C BPF TUNED FOR 810MHz RF FREQUENCY)**

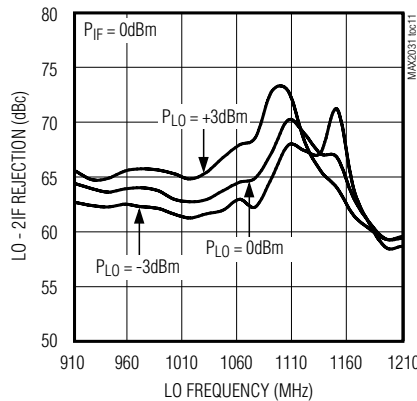

**LO - 2IF REJECTION vs. LO FREQUENCY  
(L-C BPF TUNED FOR 810MHz RF FREQUENCY)**

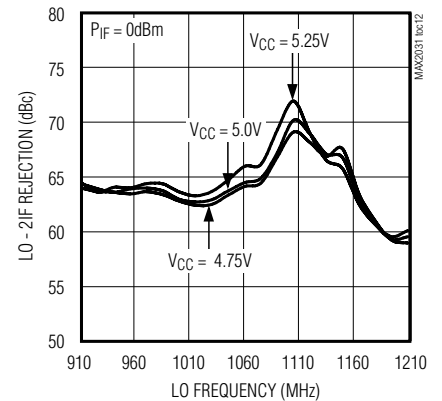

**LO + 3IF REJECTION vs. LO FREQUENCY  
(L-C BPF TUNED FOR 810MHz RF FREQUENCY)**

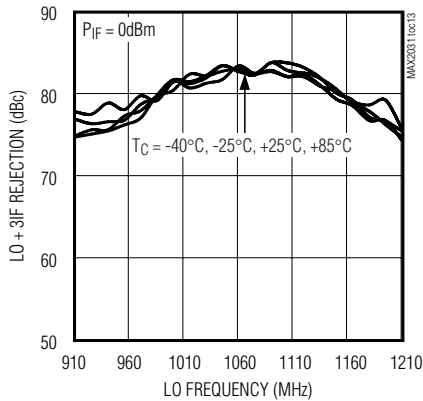

**LO + 3IF REJECTION vs. LO FREQUENCY  
(L-C BPF TUNED FOR 810MHz RF FREQUENCY)**

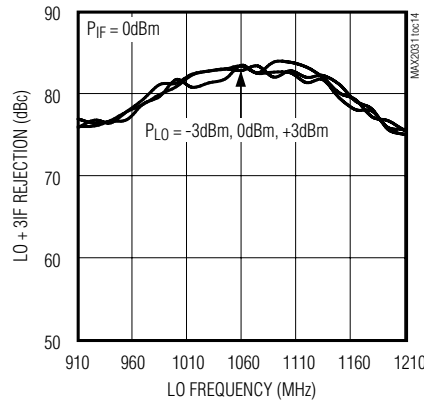

**LO + 3IF REJECTION vs. LO FREQUENCY  
(L-C BPF TUNED FOR 810MHz RF FREQUENCY)**

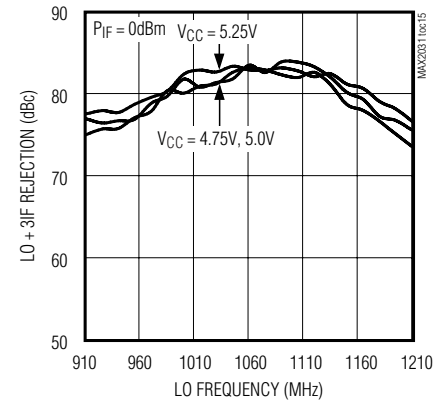

**LO - 3IF REJECTION vs. LO FREQUENCY  
(L-C BPF TUNED FOR 810MHz RF FREQUENCY)**

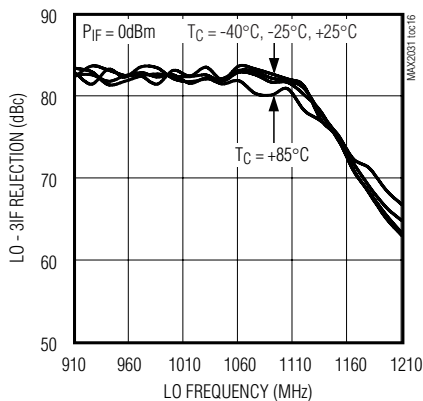

**LO - 3IF REJECTION vs. LO FREQUENCY  
(L-C BPF TUNED FOR 810MHz RF FREQUENCY)**

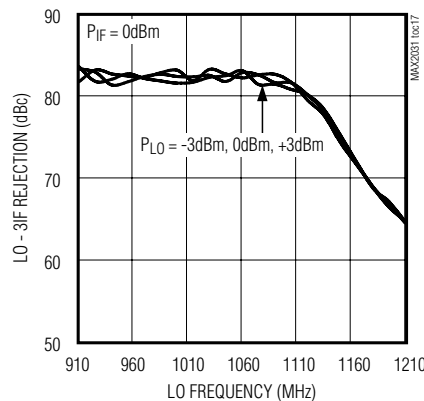

**LO - 3IF REJECTION vs. LO FREQUENCY  
(L-C BPF TUNED FOR 810MHz RF FREQUENCY)**

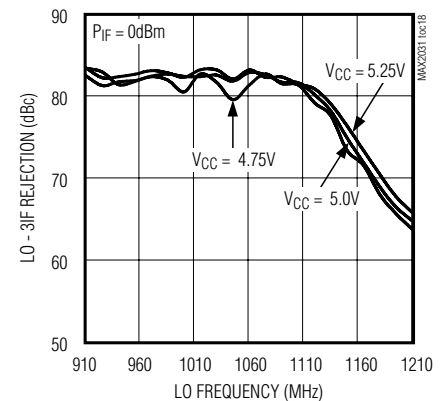

# High-Linearity, 815MHz to 1000MHz Upconversion/Downconversion Mixer with LO Buffer/Switch

## Typical Operating Characteristics (continued)

(Typical Application Circuit, L1 = 4.7nH, C4 = 6pF, C5 not used, VCC = +5.0V, PLO = 0dBm, PIF = 0dBm, fRF = fLO + fIF, fIF = 160MHz, unless otherwise noted.)

### Upconverter Curves

**LO LEAKAGE AT RF PORT vs. LO FREQUENCY (L-C BPF TUNED FOR 810MHz RF FREQUENCY)**

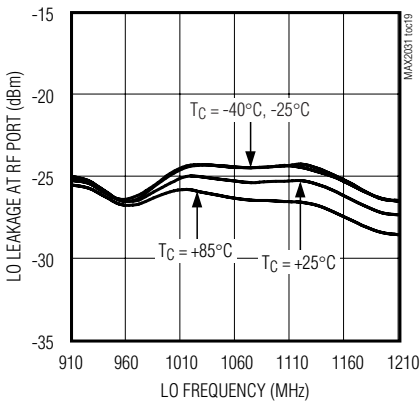

**LO LEAKAGE AT RF PORT vs. LO FREQUENCY (L-C BPF TUNED FOR 810MHz RF FREQUENCY)**

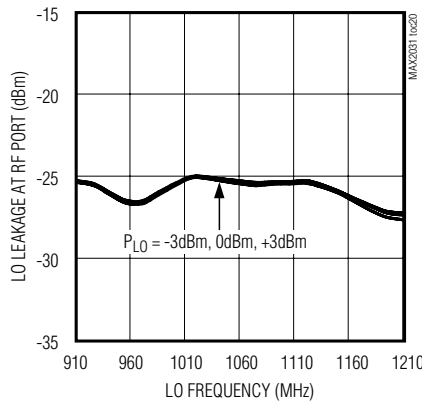

**LO LEAKAGE AT RF PORT vs. LO FREQUENCY (L-C BPF TUNED FOR 810MHz RF FREQUENCY)**

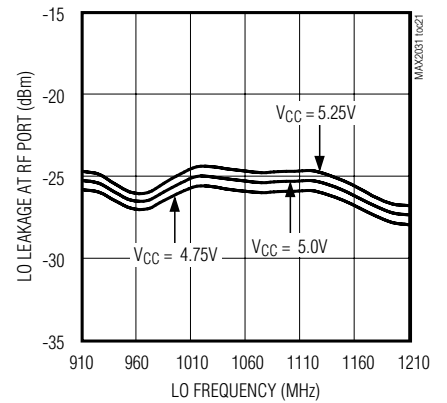

**IF LEAKAGE AT RF vs. LO FREQUENCY (L-C BPF TUNED FOR 810MHz RF FREQUENCY)**

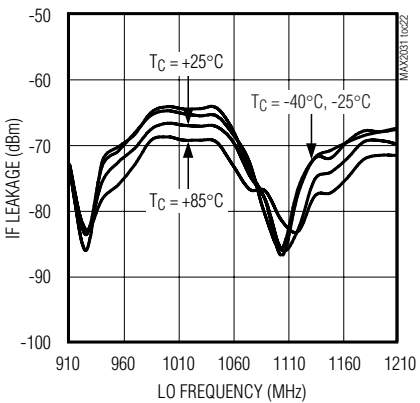

**IF LEAKAGE AT RF vs. LO FREQUENCY (L-C BPF TUNED FOR 810MHz RF FREQUENCY)**

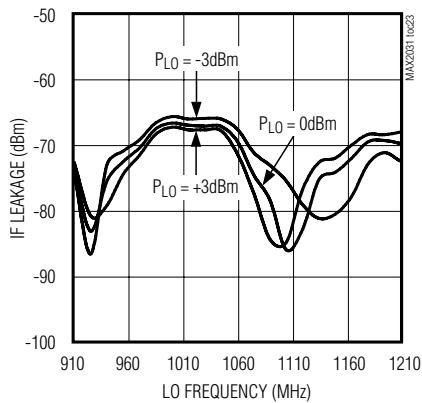

**IF LEAKAGE AT RF vs. LO FREQUENCY (L-C BPF TUNED FOR 810MHz RF FREQUENCY)**

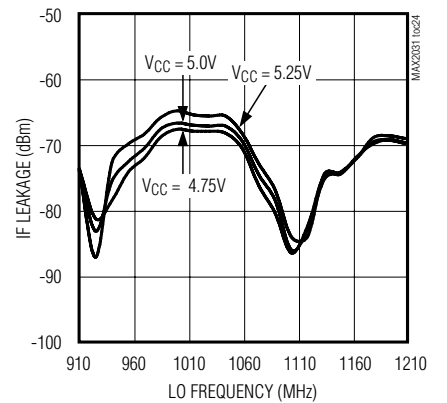

**RF PORT RETURN LOSS vs. RF FREQUENCY (L-C BPF TUNED FOR 810MHz RF FREQUENCY)**

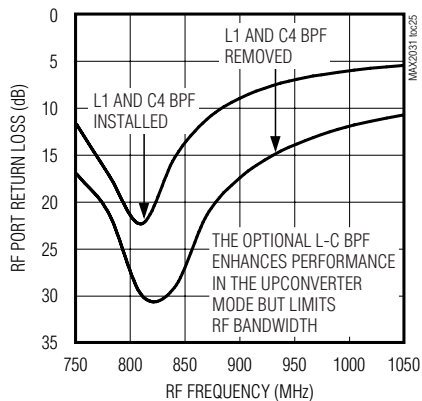

# High-Linearity, 815MHz to 1000MHz Upconversion/Downconversion Mixer with LO Buffer/Switch

## Pin Description

PIN	NAME	FUNCTION
1, 6, 8, 14	VCC	Power-Supply Connection. Bypass each VCC pin to GND with capacitors as shown in the <i>Typical Application Circuit</i> .
2	RF	Single-Ended 50Ω RF Input/Output. This port is internally matched and DC shorted to GND through a balun.
3	TAP	Center Tap of the Internal RF Balun. Connect to ground.
4, 5, 10, 12, 13, 16, 17, 20	GND	Ground
7	LOBIAS	Bias Resistor for Internal LO Buffer. Connect a 523Ω ±1% resistor from LOBIAS to the power supply.
9	LOSEL	Local Oscillator Select. Logic-control input for selecting LO1 or LO2.
11	LO1	Local Oscillator Input 1. Drive LOSEL low to select LO1.
15	LO2	Local Oscillator Input 2. Drive LOSEL high to select LO2.
18, 19	IF-, IF+	Differential IF Input/Outputs
EP	GND	Exposed Ground Paddle. Solder the exposed paddle to the ground plane using multiple vias.

## Detailed Description

The MAX2031 can operate either as a downconverter or an upconverter mixer that provides approximately 7dB of conversion loss with a typical 7dB noise figure. IIP3 is +36dBm for both upconversion and downconversion modes. The integrated baluns and matching circuitry allow for 50Ω single-ended interfaces to the RF port and the two LO ports. The RF port can be used as an input for downconversion or an output for upconversion. A single-pole, double-throw (SPDT) switch provides 50ns switching time between the two LO inputs with 49dB of LO-to-LO isolation. Furthermore, the integrated LO buffer provides a high drive level to the mixer core, reducing the LO drive required at the MAX2031's inputs to a -3dBm to +3dBm range. The IF port incorporates a differential output for downconversion, which is ideal for providing enhanced IIP2 performance. For upconversion, the IF port is a differential input.

Specifications are guaranteed over broad frequency ranges to allow for use in cellular band WCDMA, cdmaOne™, cdma2000, and GSM 850/GSM 900 2.5G EDGE base stations. The MAX2031 is specified to operate over an 815MHz to 1000MHz RF frequency range, a 960MHz to 1180MHz LO frequency range, and a DC to 250MHz IF frequency range. Operation beyond these ranges is possible; see the *Typical Operating Characteristics* for additional details.

The MAX2031 is optimized for high-side LO injection architectures. However, the device can operate in low-side LO injection applications with an extended LO range, but performance degrades as  $f_{LO}$  decreases. See

the *Typical Operating Characteristics* for measurements taken with  $f_{LO}$  below 960MHz. For a pin-compatible device that has been optimized for LO frequencies below 960MHz, contact the factory.

### RF Port and Balun

For using the MAX2031 as a downconverter, the RF input is internally matched to 50Ω, requiring no external matching components. A DC-blocking capacitor is required because the input is internally DC shorted to ground through the on-chip balun. For upconverter operation, the RF port is a single-ended output similarly matched to 50Ω.

### LO Inputs, Buffer, and Balun

The MAX2031 is optimized for high-side LO injection architectures with a 960MHz to 1180MHz LO frequency range. For a device with a 325MHz to 850MHz LO frequency range, contact the factory. As an added feature, the MAX2031 includes an internal LO SPDT switch that can be used for frequency-hopping applications. The switch selects one of the two single-ended LO ports, allowing the external oscillator to settle on a particular frequency before it is switched in. LO switching time is typically less than 50ns, which is more than adequate for nearly all GSM applications. If frequency hopping is not employed, set the switch to either of the LO inputs. The switch is controlled by a digital input (LOSEL): logic-high selects LO2, logic-low selects LO1. To avoid damage to the part, voltage MUST be applied to VCC before digital logic is applied to LOSEL (see the *Absolute Maximum Ratings*). LO1 and LO2 inputs are internally matched to 50Ω, requiring an 82pF DC-blocking capacitor at each input.

cdmaOne is a trademark of CDMA Development Group.

# High-Linearity, 815MHz to 1000MHz Upconversion/Downconversion Mixer with LO Buffer/Switch

A two-stage internal LO buffer allows a wide input-power range for the LO drive. All guaranteed specifications are for a -3dBm to +3dBm LO signal power. The on-chip low-loss balun, along with an LO buffer, drives the double-balanced mixer. All interfacing and matching components from the LO inputs to the IF outputs are integrated on-chip.

## High-Linearity Mixer

The core of the MAX2031 is a double-balanced, high-performance passive mixer. Exceptional linearity is provided by the large LO swing from the on-chip LO buffer.

## Differential IF

The MAX2031 mixer has a DC to 250MHz IF frequency range. Note that these differential ports are ideal for providing enhanced IIP2 performance. Single-ended IF applications require a 1:1 balun to transform the 50Ω differential IF impedance to 50Ω single-ended. Including the balun, the IF return loss is better than 15dB. The differential IF is used as an input port for upconverter operation. The user can use a differential IF amplifier following the mixer, but a DC block is required on both IF pins.

## Applications Information

### Input and Output Matching

The RF and LO inputs are internally matched to 50Ω. No matching components are required. As a downconverter, the return loss at the RF port is typically better than 15dB over the entire input range (815MHz to 1000MHz), and return loss at the LO ports are typically 15dB (960MHz to 1180MHz). RF and LO inputs require only DC-blocking capacitors for interfacing.

An optional L-C bandpass filter (BPF) can be installed at the RF port to improve upconverter performance. See the *Typical Application Circuit* and *Typical Operating Characteristics* for upconverter operation with an L-C BPF tuned for 810MHz RF frequency. Performance can be optimized at other frequencies by choosing different values for L1 and C4. Removing L1 and C4 altogether results in a broader match, but performance degrades. Contact factory for details.

The IF output impedance is 50Ω (differential). For evaluation, an external low-loss 1:1 (impedance ratio) balun transforms this impedance to a 50Ω single-ended output (see the *Typical Application Circuit*).

### Bias Resistor

Bias current for the LO buffer is optimized by fine tuning resistor R1. If reduced current is required at the expense of performance, contact the factory for details. If the ±1% bias resistor values are not readily available, substitute standard ±5% values.

## Layout Considerations

A properly designed PC board is an essential part of any RF/microwave circuit. Keep RF signal lines as short as possible to reduce losses, radiation, and inductance. For the best performance, route the ground-pin traces directly to the exposed pad under the package. The PC board exposed pad **MUST** be connected to the ground plane of the PC board. It is suggested that multiple vias be used to connect this pad to the lower-level ground planes. This method provides a good RF/thermal conduction path for the device. Solder the exposed pad on the bottom of the device package to the PC board. The MAX2031 evaluation kit can be used as a reference for board layout. Gerber files are available upon request at [www.maxim-ic.com](http://www.maxim-ic.com).

## Power-Supply Bypassing

Proper voltage-supply bypassing is essential for high-frequency circuit stability. Bypass each VCC pin with the capacitors shown in the *Typical Application Circuit*. See Table 1.

**Table 1. Typical Application Circuit Component List**

COMPONENT	VALUE	DESCRIPTION
C1, C2, C7, C8, C10, C11, C12	82pF	Microwave capacitors (0603)
C3, C6, C9	10nF	Microwave capacitors (0603)
C4*	6pF	Microwave capacitor (0603)
C5**	2pF	Microwave capacitor (0603)
L1*	4.7nH	Inductor (0603)
R1	523Ω	±1% resistor (0603)
T1	1:1	IF balun M/A-COM: MABAES0029
U1	MAX2031	Maxim IC

\*C4 and L1 installed only when mixer is used as an upconverter.

\*\*C5 installed only when mixer is used as a downconverter.

## Exposed Pad RF/Thermal Considerations

The exposed paddle (EP) of the MAX2031's 20-pin thin QFN-EP package provides a low-thermal-resistance path to the die. It is important that the PC board on which the MAX2031 is mounted be designed to conduct heat from the EP. In addition, provide the EP with a low-inductance path to electrical ground. The EP **MUST** be soldered to a ground plane on the PC board, either directly or through an array of plated via holes.

# High-Linearity, 815MHz to 1000MHz Upconversion/ Downconversion Mixer with LO Buffer/Switch

## Typical Application Circuit

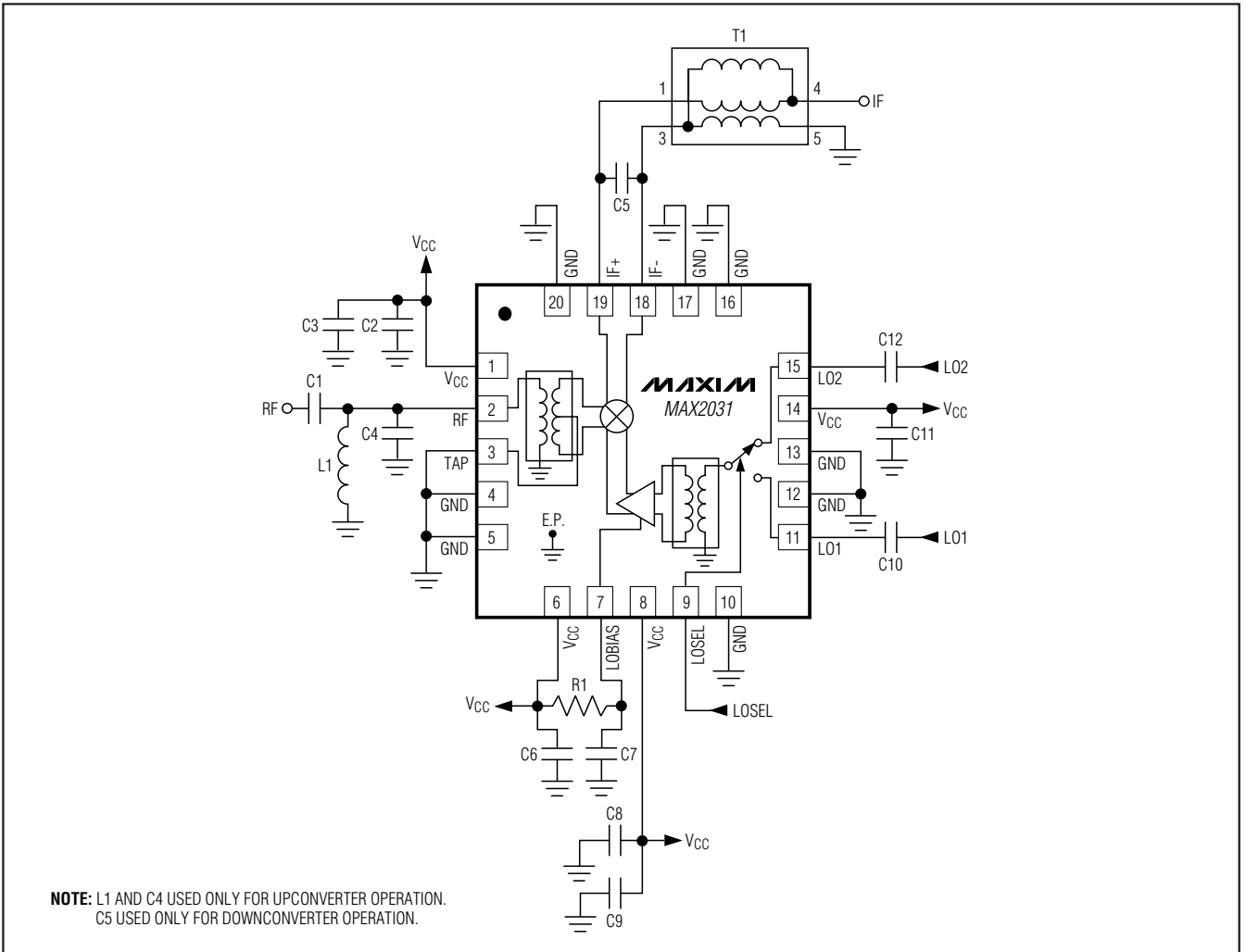

### Chip Information

TRANSISTOR COUNT: 1017

PROCESS: SiGe BiCMOS

# High-Linearity, 815MHz to 1000MHz Upconversion/Downconversion Mixer with LO Buffer/Switch

## Package Information

(The package drawing(s) in this data sheet may not reflect the most current specifications. For the latest package outline information go to [www.maxim-ic.com/packages](http://www.maxim-ic.com/packages).)

MAX2031

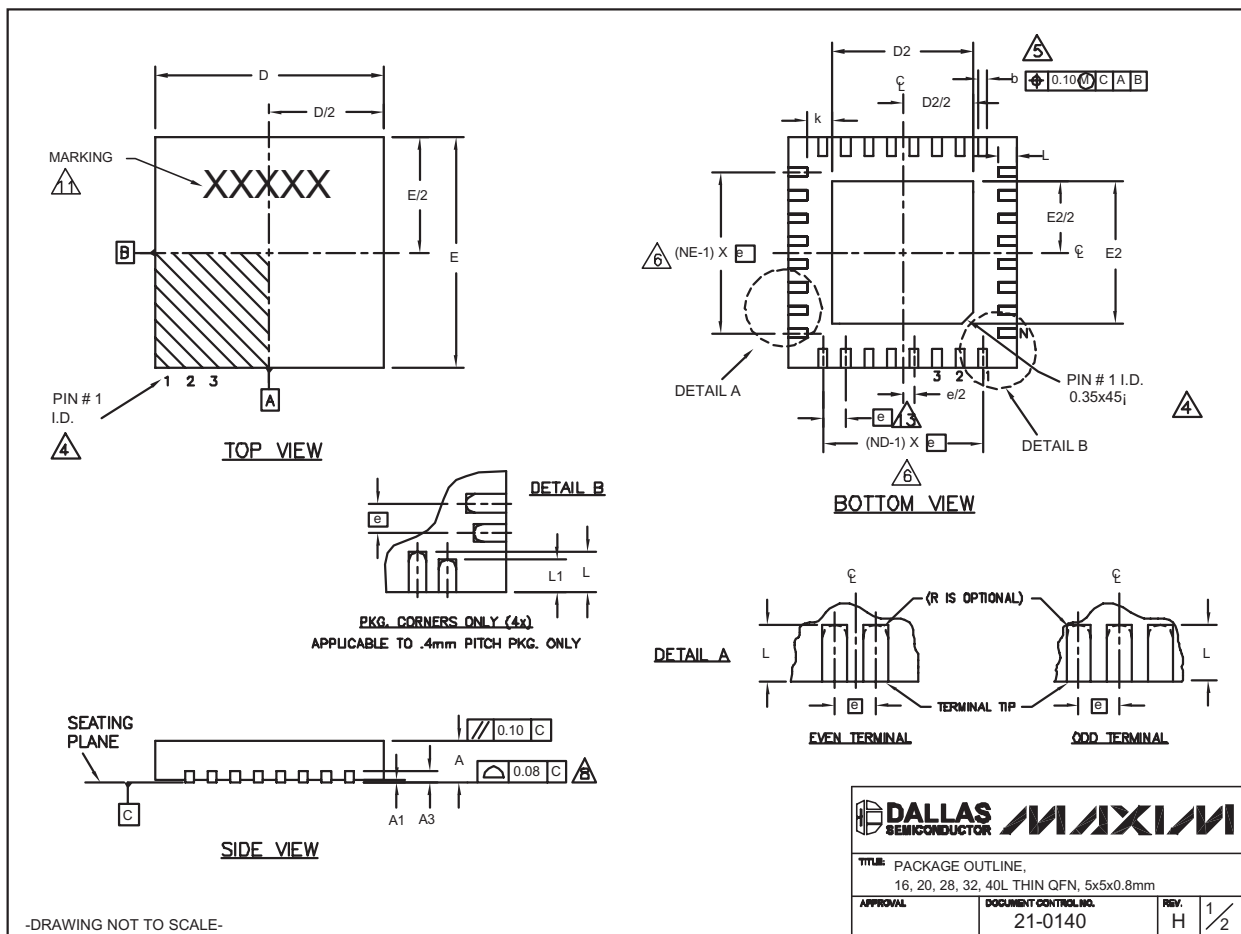

QFN THIN EPS

# High-Linearity, 815MHz to 1000MHz Upconversion/Downconversion Mixer with LO Buffer/Switch

## Package Information (continued)

(The package drawing(s) in this data sheet may not reflect the most current specifications. For the latest package outline information go to [www.maxim-ic.com/packages](http://www.maxim-ic.com/packages).)

COMMON DIMENSIONS															
PKG.	16L 5x5			20L 5x5			28L 5x5			32L 5x5			40L 5x5		
SYMBOL	MIN.	NOM.	MAX.	MIN.	NOM.	MAX.	MIN.	NOM.	MAX.	MIN.	NOM.	MAX.	MIN.	NOM.	MAX.
A	0.70	0.75	0.80	0.70	0.75	0.80	0.70	0.75	0.80	0.70	0.75	0.80	0.70	0.75	0.80
A1	0	0.02	0.05	0	0.02	0.05	0	0.02	0.05	0	0.02	0.05	0	0.02	0.05
A3	0.20 REF.			0.20 REF.			0.20 REF.			0.20 REF.			0.20 REF.		
b	0.25	0.30	0.35	0.25	0.30	0.35	0.20	0.25	0.30	0.20	0.25	0.30	0.15	0.20	0.25
D	4.90	5.00	5.10	4.90	5.00	5.10	4.90	5.00	5.10	4.90	5.00	5.10	4.90	5.00	5.10
E	4.90	5.00	5.10	4.90	5.00	5.10	4.90	5.00	5.10	4.90	5.00	5.10	4.90	5.00	5.10
e	0.80 BSC.			0.65 BSC.			0.50 BSC.			0.50 BSC.			0.40 BSC.		
k	0.25	-	-	0.25	-	-	0.25	-	-	0.25	-	-	0.25	0.35	0.45
L	0.30	0.40	0.50	0.45	0.55	0.65	0.45	0.55	0.65	0.30	0.40	0.50	0.40	0.50	0.60
L1	-	-	-	-	-	-	-	-	-	-	-	-	0.30	0.40	0.50
N	16			20			28			32			40		
ND	4			5			7			8			10		
NE	4			5			7			8			10		
JEDEC	WHHB			WHHC			WHHD-1			WHHD-2			-----		

EXPOSED PAD VARIATIONS									
PKG. CODES	D2			E2			L	DOWN BONDS ALLOWED	
	MIN.	NOM.	MAX.	MIN.	NOM.	MAX.			-0.15
T1655-1	3.00	3.10	3.20	3.00	3.10	3.20	**	NO	
T1655-2	3.00	3.10	3.20	3.00	3.10	3.20	**	YES	
T1655N-1	3.00	3.10	3.20	3.00	3.10	3.20	**	NO	
T2055-2	3.00	3.10	3.20	3.00	3.10	3.20	**	NO	
T2055-3	3.00	3.10	3.20	3.00	3.10	3.20	**	YES	
T2055-4	3.00	3.10	3.20	3.00	3.10	3.20	**	NO	
T2055-5	3.15	3.25	3.35	3.15	3.25	3.35	0.40	YES	
T2855-1	3.15	3.25	3.35	3.15	3.25	3.35	**	NO	
T2855-2	2.60	2.70	2.80	2.60	2.70	2.80	**	NO	
T2855-3	3.15	3.25	3.35	3.15	3.25	3.35	**	YES	
T2855-4	2.60	2.70	2.80	2.60	2.70	2.80	**	YES	
T2855-5	2.60	2.70	2.80	2.60	2.70	2.80	**	NO	
T2855-6	3.15	3.25	3.35	3.15	3.25	3.35	**	NO	
T2855-7	2.60	2.70	2.80	2.60	2.70	2.80	**	YES	
T2855-8	3.15	3.25	3.35	3.15	3.25	3.35	0.40	YES	
T2855N-1	3.15	3.25	3.35	3.15	3.25	3.35	**	NO	
T3255-2	3.00	3.10	3.20	3.00	3.10	3.20	**	NO	
T3255-3	3.00	3.10	3.20	3.00	3.10	3.20	**	YES	
T3255-4	3.00	3.10	3.20	3.00	3.10	3.20	**	NO	
T3255N-1	3.00	3.10	3.20	3.00	3.10	3.20	**	NO	
T4055-1	3.20	3.30	3.40	3.20	3.30	3.40	**	YES	

\*\* SEE COMMON DIMENSIONS TABLE

NOTES:

- DIMENSIONING & TOLERANCING CONFORM TO ASME Y14.5M-1994.
- ALL DIMENSIONS ARE IN MILLIMETERS. ANGLES ARE IN DEGREES.
- N IS THE TOTAL NUMBER OF TERMINALS.
- THE TERMINAL #1 IDENTIFIER AND TERMINAL NUMBERING CONVENTION SHALL CONFORM TO JESD 95-1 SPP-012. DETAILS OF TERMINAL #1 IDENTIFIER ARE OPTIONAL, BUT MUST BE LOCATED WITHIN THE ZONE INDICATED. THE TERMINAL #1 IDENTIFIER MAY BE EITHER A MOLD OR MARKED FEATURE.
- DIMENSION b APPLIES TO METALLIZED TERMINAL AND IS MEASURED BETWEEN 0.25 mm AND 0.30 mm FROM TERMINAL TIP.
- ND AND NE REFER TO THE NUMBER OF TERMINALS ON EACH D AND E SIDE RESPECTIVELY.
- DEPOPULATION IS POSSIBLE IN A SYMMETRICAL FASHION.
- COPLANARITY APPLIES TO THE EXPOSED HEAT SINK SLUG AS WELL AS THE TERMINALS.
- DRAWING CONFORMS TO JEDEC MO220, EXCEPT EXPOSED PAD DIMENSION FOR T2855-1, T2855-3, AND T2855-6.
- WARPAGE SHALL NOT EXCEED 0.10 mm.
- MARKING IS FOR PACKAGE ORIENTATION REFERENCE ONLY.
- NUMBER OF LEADS SHOWN ARE FOR REFERENCE ONLY.
- LEAD CENTERLINES TO BE AT TRUE POSITION AS DEFINED BY BASIC DIMENSION "e", -0.05.

-DRAWING NOT TO SCALE-

TITLE: PACKAGE OUTLINE, 16, 20, 28, 32, 40L THIN QFN, 5x5x0.8mm			
APPROVAL	DOCUMENT CONTROL NO.	REV.	2/2
	21-0140	H	

Maxim cannot assume responsibility for use of any circuitry other than circuitry entirely embodied in a Maxim product. No circuit patent licenses are implied. Maxim reserves the right to change the circuitry and specifications without notice at any time.

16 **Maxim Integrated Products, 120 San Gabriel Drive, Sunnyvale, CA 94086 408-737-7600**